

# 45-0474 PLUG AERATOR

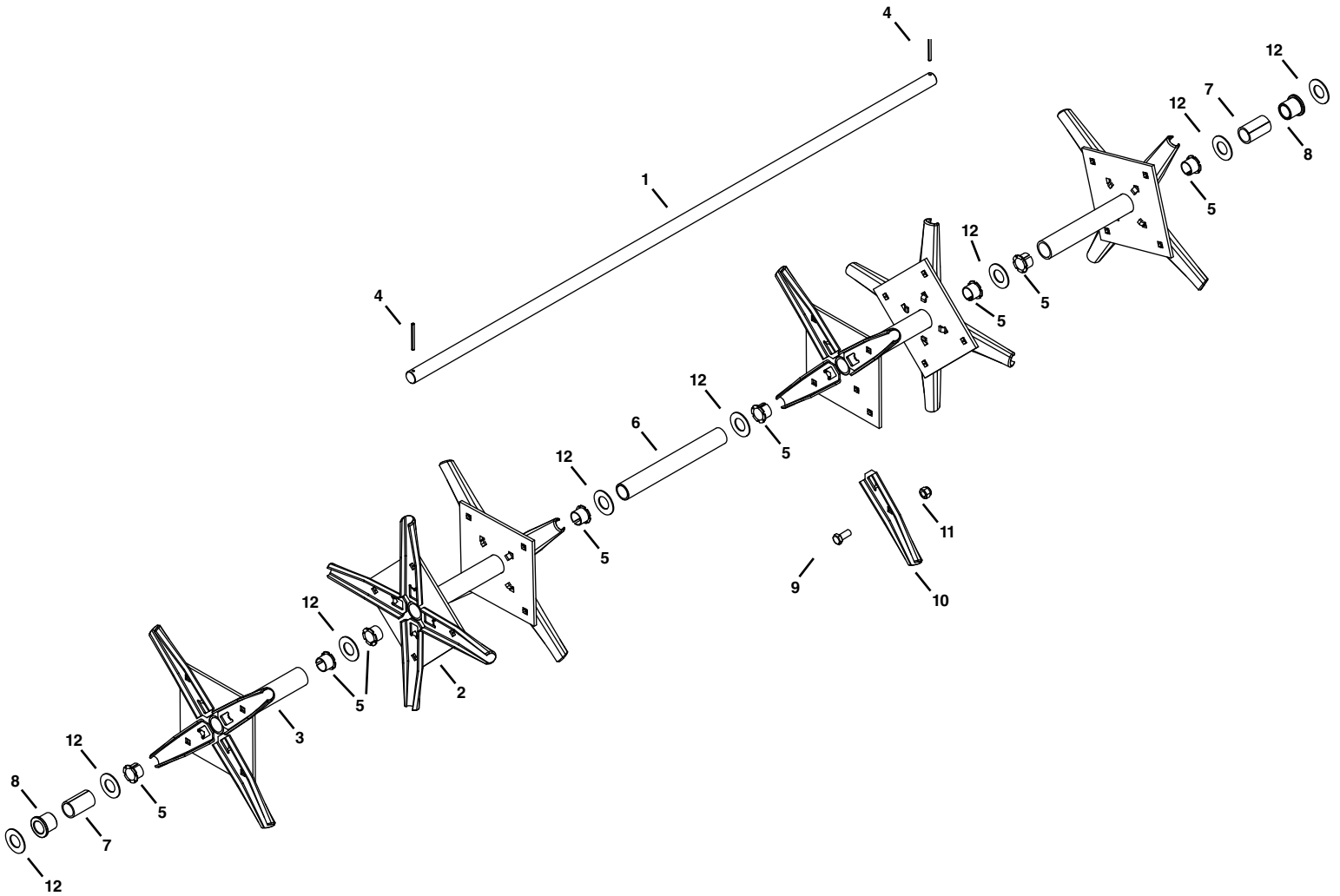

REF	QTY	PART NO.	DESCRIPTION	REF	QTY	PART NO.	DESCRIPTION
1	1	26369	Shaft	8	2	44798	Flange Bearing
2	2	63929	Spool Assembly (Double)	9	24	47810	Nylock Nut, 5/16"
3	2	63930	Spool Assembly (Single)	10	24	24924	Aerator Knife
4	2	41631	Cotter Pin, 5/32 x 1-1/4"	11	24	43080	Carriage Bolt, 5/16-18 x 3/4"
5	8	741-0493A	Split Bearing, 3/4"	12	8	1540-31	Washer, .78" x 1.25" x .062"
6	1	46500	Spacer, .82" x 1" x 7.88"		1	41260	Instruction Sheet
7	2	48665	Spacer, .8" x 1" x 1.65"				

Want more information or assembly tips?



**Video  
Instruction  
Guide**

[youtube.com/c/agrifab](https://www.youtube.com/c/agrifab)

FORM NO. 41260 rev. (09/14/20)

# 588 21 27-01 PLUG AERATOR

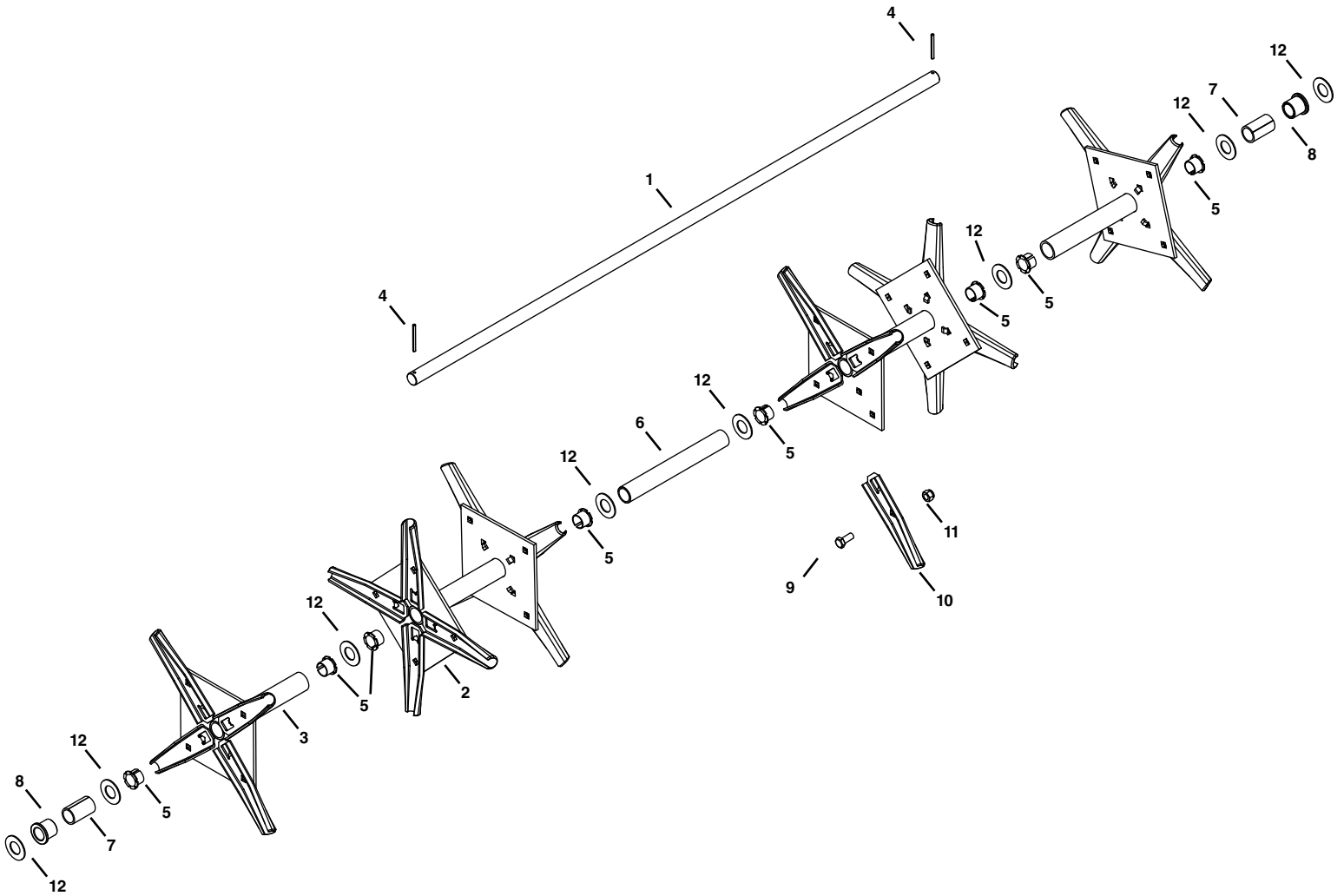

REF	QTY	PART NO.	DESCRIPTION	REF	QTY	PART NO.	DESCRIPTION
1	1	586 80 27-01	Shaft	8	2	504 06 63-01	Flange Bearing
2	2	588 63 77-01	Spool Assembly (Double)	9	24	501 02 11-01	Nylock Nut, 5/16"
3	2	588 63 78-01	Spool Assembly (Single)	10	24	588 63 81-01	Aerator Knife
4	2	531 00 27-38	Cotter Pin, 5/32 x 1-1/4"	11	24	522 75 63-01	Carriage Bolt, 5/16-18 x 3/4"
5	8	501 33 74-01	Split Bearing, 3/4"	12	8	586 80 77-01	Washer, .78" x 1.25" x .062"
6	1	588 63 80-01	Spacer, .82" x 1" x 7.88"		1	41260	Instruction Sheet
7	2	531 00 76-01	Spacer, .8" x 1" x 1.65"				